

JA

- Only for Use in Approved Enclosed Halogen Fixtures
- P14.5s Base
- 12 & 28 Volts

Watts	Ushio Ordering Code	Ushio Lamp Description	Volts	Dimensions mm			Filament Type	Luminous Flux lm	Color Temp K	Avg Life h
				Dia (A)	MOL (B)	Length (L1)				
<b>P14.5s Base</b>										
55	1000790	JA12V-55W H1-55	12	8.5	67.5	25.25	C-8	1550	3000	150
70	1000800	JA24V-70W*	28	8.5	49.0	—	—	1900	—	15
100	1000785	JA12V-100W H1-100	12	8.5	67.5	25.25	C-8	2700	3050	50

\* Special Order Item

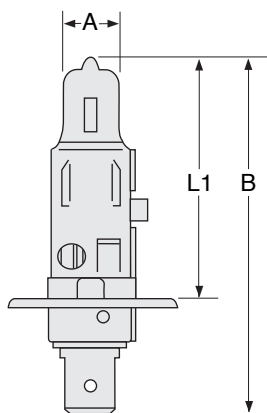

P14.5s

## JC, JD, JCV

- Only for Use in Approved Enclosed Halogen Fixtures
- Single Contact Bayonet Base - BA9s
- Double Contact Bayonet Base - BA15d
- Universal Burn Position



Watts	Ushio Ordering Code	Ushio Lamp Description	Dimensions mm			Filament Type	Approx Lumens lm	Color Temp K	Avg Life h	Bulb Finish
			Dia (A)	MOL (B)	LCL (C)					
<b>Single Contact Bayonet Base – BA9s</b>										
5	1000832	JC12V-5W/BA9S	9.0	28.0	15.0	C-2R	80	3000	240	Clear
10	1000810	JC12V-10W/BA9S	9.0	28.0	15.0	C-6	200	—	240	Clear
20	1000819	JC12V-20W/BA9S	8.0	30.0	13.5	C-6	340	2900	2000	Clear
<b>Double Contact Bayonet Base – BA15d</b>										
60	1000915	JCD24V-60W	12.5	60.5	35.0	CC-6	1260	—	500	Clear
75	1000916	JCD24V-75W	11.0	55.0	34.9	CC-6	1600	3100	500	Clear
75	1000917	JCD28V-75W/WGB	13.5	63.5	35.0	CC-6	1400	2950	2000	Clear
75	1000986	JCV120V-75WGB	12.0	59.0	35.0	CC-8	1200	2800	1000	Clear
75	1000987	JCV120V-75WGBF	14.0	72.0	35.0	CC-8	1125	2850	1000	Frosted
100	1000968	JCV120V-100WGB	13.0	62.0	35.0	CC-8	1600	2800	2000	Clear
100	1000969	JCV120V-100WGBF	13.0	62.0	35.0	CC-8	1550	2800	2000	Frosted
100	1000364	ESR, JCV120V-100WGB2	13.0	62.0	35.0	CC-2V	1800	2850	750	Clear
100	1000374	ETD, JCV120V-100WGB2F	13.0	62.0	35.0	CC-2V	1750	2850	750	Frosted
125	1000814	JC12V-125WB/BA15D*	15.0	49.0	28.8	C-8	1900	2800	1000	Clear
150	1000373	ETC, JCV120V-150WGB	13.0	62.0	35.0	CC-8	2800	2900	2000	Clear
150	1000362	ESP, JCV120V-150WGB2	13.0	62.0	35.0	CC-2V	2800	2900	1000	Clear
150	1000376	ETF, JCV120V-150WGBF	13.0	62.0	35.0	CC-8	2700	2900	2000	Frosted
200	1000512	FEV, JCV120V-200WCB2	13.0	62.0	35.0	CC-2V	5500	3200	50	Clear
200	1001803	JCV230V-200WGB	15.0	63.0	35.1	CC-8	5000	2800	2000	Clear
250	1000365	ESS, JCV120V-250WGB	13.0	76.0	41.0	CC-8	5000	3000	2000	Clear
250	1000372	ETB, JCV120V-250WGBF	13.0	76.0	41.0	CC-8	4800	3000	2000	Frosted
250	1000990	JCV130V-250WGBF*	13.0	76.0	41.0	CC-8	4800	3000	2000	Frosted
500	1000979	JCV120V-500WGB	13.0	87.0	54.0	CC-8	10450	2950	2000	Clear
500	1000980	JCV120V-500WGBF	13.0	87.0	54.0	CC-8	10100	2950	2000	Frosted

\* Special Order Item

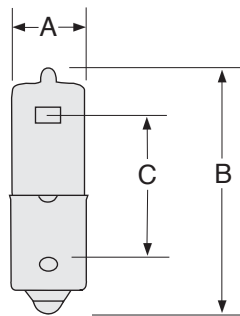

BA9s

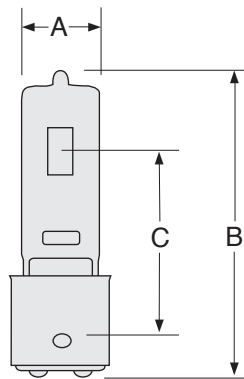

BA15d



## JC

- Only for Use in Approved Enclosed Halogen Fixtures
- Miniature 2-Pin Base - G4
- Universal Burn Position



Watts	Ushio Ordering Code	Ushio Lamp Description	Dimensions mm			Filament Type	Approx Lumens lm	Color Temp K	Avg Life h	Bulb Finish
			Dia (A)	MOL (B)	LCL (C)					
<b>Miniature 2-Pin Base – G4</b>										
5	1000874	JC6V-5W/G4*	9.0	28.0	19.5	C-6	100	3006	50	Clear
5	1000833	JC12V-5W/G4	9.0	28.0	19.5	C-2R	60	2720	2000	Clear
8	1000878	JC6V-8W/G4*	9.0	28.0	19.5	C-6	163	3168	50	Clear
10	1000856	JC6V-10W/G4	9.0	30.0	19.5	C-6	130	2850	2000	Clear
10	1000857	JC6V-10WH3 (64223)	8.0	31.0	19.5	C-6	150	2900	300	Clear
10	1000531	FHD/ESA, JC6V-10W	9.0	30.0	19.5	C-6	200	3200	100	Clear
10	1003030	JC12V-10W/G4	9.0	30.0	19.5	C-6	120	2800	2000	Clear
10	1000811	JC12V-10W/G4	9.0	28.0	19.5	C-2R	140	2900	2000	Clear
10	1000813	JC12V-10WF/G4	9.0	30.0	19.5	C-6	115	2800	2000	Frosted
10	1000812	JC12V-10W/G4	9.0	28.0	19.5	C-2R	175	2916	300	Clear
15	1000861	JC6V-15W/G4	9.0	28.0	19.5	C-6	300	3138	100	Clear
20	1000532	FHE/ESB, JC6V-20W	9.0	30.0	19.5	C-6	450	3200	100	Clear
20	1000866	JC6V-20W/G4	9.0	30.0	19.5	C-6	280	2850	2000	Clear
20	1000821	JC12V-20W/G4	9.0	30.0	19.5	C-6	350	2850	2000	Clear
20	1000804	JC12V-20W/G4	9.0	30.0	19.5	C-8	350	2850	2000	Clear
20	1000820	JC12V-20WF/G4	9.0	30.0	19.5	C-6	330	2900	2000	Frosted
20	1000844	JC24V-20W/G4	9.0	30.0	19.5	C-6	280	2850	2000	Clear
30	1000867	JC6V-30W/G4	9.0	30.0	19.25	C-6	800	3300	50	Clear
35	1000825	JC12V-35WB/G4	9.0	30.0	19.5	C-6	650	2900	2000	Clear

\* Special Order Item

Originally developed as light sources for optical instruments, JC lamps feature an overall compact design with precise LCL placement. The exceptional brightness of this compact lamp make this series an ideal choice for task light applications.

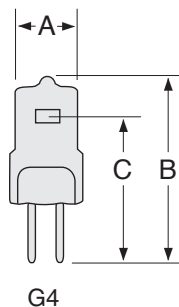

## JC, JCD & JCV

- Only for Use in Approved Enclosed Halogen Fixtures
- Miniature 2-Pin Base - G5.3

Watts	Ushio Ordering Code	Ushio Lamp Description	Dimensions mm			Filament Type	Approx Lumens lm	Color Temp K	Avg Life h	Burn Position	Bulb Finish	Fig No
			Dia (A)	MOL (B)	LCL (C)							
<b>Miniature 2-Pin Base – G5.3</b>												
30	1000254	DZA, JC10.8V-30W	11.5	51.0	27.0	C-6	600	3100	400	BD/Hor	Clear	1
50	1000837	JC14.5V-50WC	11.5	55.0	32.0	CBar6	1250	3200	100	BD/Hor	Clear	1
80	1000253	DYT, JC19V-80W*	11.5	51.0	27.0	CBar6	2600	3350	25	BD/Hor	Clear	1
100	1000649	GCC, JC12V-100WC5	11.5	57.0	32.0	CBar6	2900	3300	200	BD/Hor	Clear	1
100	1000255	DZB, JC12V-100W*	11.5	51.0	27.0	CBar6	3100	3400	50	BD/Hor	Clear	1
125	1000605	FSH, JCV120V-125WB	11.5	57.0	32.0	CC-8	2500	3000	200	BD/Hor	Clear	4
175	1000330	EML, JC24V-175W*	13.5	57.2	27.0	CBar6	5600	3200	125	BD/Hor	Clear	1
200	1000648	GCB, JCD30V-200WC1	11.5	57.0	32.0	CC-6	5300	3200	200	BD/Hor	Clear	2
250	1000453	EYH/FKT, JCD120V-250WB	22.0	63.5	36.5	CC-6	6050	3050	150	BD/Hor	Clear	3
250	1000647	GCA, JCV120V-250WC	11.5	57.0	32.0	CC-8	5880	3200	200	BD/Hor	Clear	4
300	1000899	JCD120V-300WCP	22.0	62.0	37.0	CC-6	7350	3200	100	BD/Hor	Clear	3
360	1000442	EYB, JCD82V-360W	11.5	57.0	31.8	CC-8	10000	3300	75	BD/Hor	Clear	2
360	1000443	EYB-5, JCD86V-360WS	11.5	57.0	31.8	CC-8	10000	3300	75	BD/Hor	Clear	2
500	1000476	FBG/FBD, JCD120V-500WCP	22.0	76.0	44.5	CC-6	13200	3200	50	BD/Hor	Clear	3
600	1000246	DYH, JCD120V-600WCP	22.0	63.0	36.5	CC-6	17000	3200	75	BD/Hor	Clear	3
650	1000225	DVY, JCD120V-650WSP	22.0	63.0	36.5	CC-6	20000	3400	25	BD/Hor	Clear	3
650	1000247	DYJ, JCD230V-650WSP*	24.0	63.5	42.9	2CC-8	20000	3400	20	BD/Hor	Clear	5

\* Special Order Item

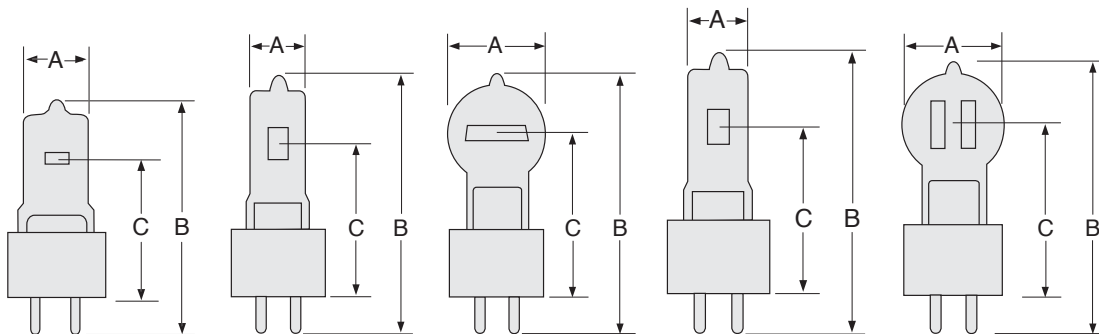
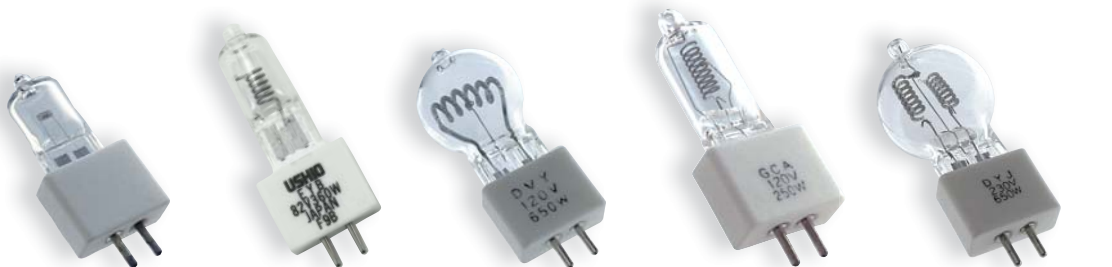

Fig.1

Fig.2

Fig.3

Fig.4

Fig.5

JC, JCD & JCV

- Only for Use in Approved Enclosed Halogen Fixtures
- 2-Pin Base - G6.35

Watts	Ushio Ordering Code	Ushio Lamp Description	Dimensions mm			Filament Type	Approx Lumens lm	Color Temp K	Avg Life h	Burn Position	Bulb Finish	Fig No
			Dia (A)	MOL (B)	LCL (C)							
<b>2-Pin Base – G6.35</b>												
20	1000822	JC12V-20W	11.0	44.0	30.0	C-6	280	2850	2000	Univ	Clear	1
30	1000868	JC6V-30WT1*	11.5	44.0	28.0	C-6	600	3200	100	Univ	Clear	1
35	1000823	JC12V-35W	11.0	44.0	30.0	C-6	650	2900	2000	Univ	Clear	1
50	1000071	BRL, JC12V-50W	11.5	44.0	30.0	CBar6	1600	3400	50	BD/Hor	Clear	2
50	1000829	JC12V-50WF	10.5	44.0	30.0	C-6	840	3000	2000	Univ	Frosted	1
50	1000830	JC12V-50WG1.0	11.0	44.0	30.0	C-6	900	2900	2000	Univ	Clear	1
50	1000848	JC24V-50W	10.5	44.0	30.0	C-6	750	2950	2000	Univ	Clear	1
75	1000834	JC12V-75W	11.0	44.0	30.0	C-6	2200	3300	2000	Univ	Clear	1
100	1000839	JC24V-100W	11.0	44.0	30.0	CC-6	1800	3000	2000	Univ	Clear	1
100	1000892	JCD120V-100W/A	13.5	50.0	30.0	CC-6	2000	3000	150	BD/Hor	Clear	3
150	1000492	FCS, JC24V-150WUI	13.5	50.0	32.0	CBar6	5000	—	50	BD/Hor	Clear	2
150	1000505	FDV, JC24V-150W	13.5	50.0	30.0	CBar6	4300	3300	100	BD/Hor	Clear	2
150	1000537	FHY, JC24V-150W	13.5	50.0	30.0	CBar6	3700	3100	1000	BD/Hor	Clear	2
150	1000920	JCD40V-150WB*	13.5	50.0	30.0	CC-6	2800	3950	500	BD/Hor	Clear	1
150	1000371	ESY, JCD100V-150WB	13.5	50.0	33.0	CC-6	3300	3075	200	BD/Hor	Clear	1
150	1000893	JCD120V-150WB	14.0	50.0	30.0	CC-6	3200	3075	100	BD/Hor	Clear	1
250	1000290	EHJ, JC24V-250W	13.5	55.0	33.0	CBar6	8500	3400	50	BD/Hor	Clear	1
250	1000382	EVC/FGX, JC24V-250W	13.0	52.0	35.0	CBar6	8400	3400	300	Univ	Clear	1
250	1000343	EPL, JCV30V-250WS1	10.0	50.0	24.5	CC-8	7500	3400	6	Univ	Clear	4
275	1000588	FNT, JC24V-275W	13.5	55.0	33.0	CBar6	10000	3400	75	BD/Hor	Clear	2
300	1000845	JC24V-300W-H*	14.0	55.0	33.0	CBar6	10200	3400	50	BD/Hor	Clear	2
300	1000216	DRA, JCD120V-300W	16.0	50.0	33.0	CC-6	6900	3100	300	BD/Hor	Clear	3
300	1002253	JCD220V-300W	22.0	65.0	37.0	2CC-8	7200	3150	50	BD/Hor	Clear	1
400	1000383	EVD, JC36V-400WS1	16.0	60.0	36.0	CBar6	16000	3400	50	BD/Hor	Clear	2
400	1002141	EVD/L, JC36V-400H1	18.0	60.0	36.0	CBar6	14500	3400	100	BD/Hor	Clear	2

\* Special Order Item

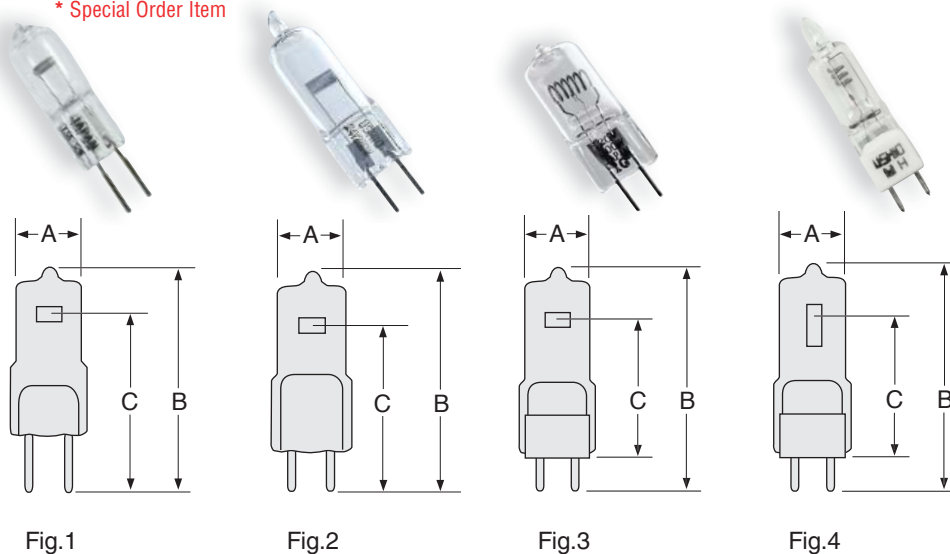

## JC, JCD & JCV

- Only for Use in Approved Enclosed Halogen Fixtures
- 2-Pin Base - G6.35/15X19 & GX6.35

Watts	Ushio Ordering Code	Ushio Lamp Description	Dimensions mm			Filament Type	Approx Lumens lm	Color Temp K	Avg Life h	Burn Position	Bulb Finish	Fig No
			Dia (A)	MOL (B)	LCL (C)							
<b>2-Pin Base – G6.35/15X19</b>												
150	1000843	JC24V-150WL-H	13.5	61.0	37.0	CBar6	4800	3400	50	BD/Hor	Clear	1
300	1000897	JCD120V-300WC/LP*	22.0	62.0	37.0	CC-6	7500	3200	70	BD/Hor	Clear	2
300	1000900	JCD120V-300WL*	22.0	63.0	37.0	CC-6	7500	3200	150	BD/Hor	Clear	2
650	1000890	JCD100V-650WL	22.0	63.0	37.0	CC-6	17750	3200	150	BD/Hor	Clear	2
650	1000907	JCD120V-650WL*	22.0	62.0	37.0	CC-6	17750	3200	150	BD/Hor	Clear	2
<b>2-Pin Base – GX6.35</b>												
300	1001762	JCD120V-300W (ref. 64514)	19.5	57.5	37.0	Special	7700	3200	75	BD/Hor	Clear	3
300	1000974	(FNS) JCV120V-300WC (64512)	16.0	57.5	30.0	CC-8	8100	3200	30	BD/Hor	Clear	4
650	1000983	JCV120V-650WC	24.0	57.5	30.0	2CC-8	1700	3200	100	BD/Hor	Clear	5
1000	1001822	JCV120V-1000WC4	23.0	67.5	38.0	2CC-8	27000	3200	100	BD/Hor	Clear	5

\* Special Order Item

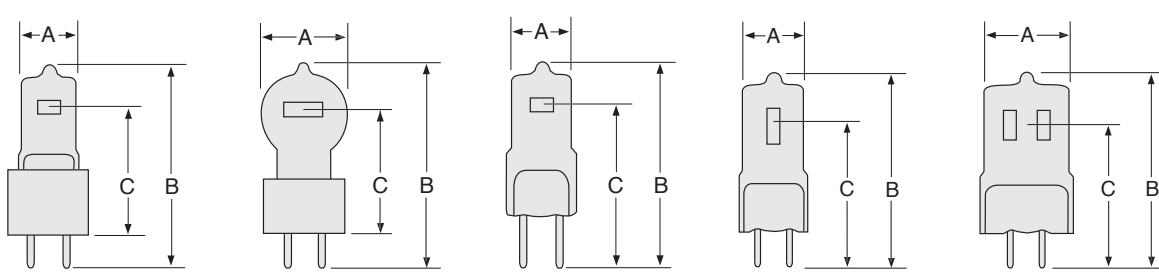

Fig.1

Fig.2

Fig.3

Fig.4

Fig.5

JC & JCD

- Only for Use in Approved Enclosed Halogen Fixtures
- 2-Pin Base - GY6.35

Watts	Ushio Ordering Code	Ushio Lamp Description	Dimensions mm			Filament Type	Approx Lumens lm	Color Temp K	Avg Life h	Burn Position	Bulb Finish	Fig No
			Dia (A)	MOL (B)	LCL (C)							
<b>2-Pin Base – GY6.35</b>												
35	1000824	JC12V-35W	11.0	44.0	30.0	C-8	650	2900	2000	BD/Hor	Clear	1
35	1003486	JC12V-35WF	11.0	44.0	30.0	C-8	650	2900	2000	BD/Hor	Frosted	1
35	1000902	JCD120V-35W	11.0	55.0	38.0	CC-2V	500	2800	1500	BD/Hor	Clear	2
50	1000827	JC12V-50W	11.0	44.0	30.0	C-6	1000	3000	2000	Univ	Clear	3
50	1000828	JC12V-50W	11.0	44.0	30.0	C-8	1000	3000	2000	Univ	Clear	3
50	1003487	JC12V-50WF	11.0	44.0	30.0	C-8	1000	3000	2000	Univ	Frosted	3
50	1000905	JCD120V-50W	11.0	55.0	38.0	CC-2V	700	2800	1500	BD/Hor	Clear	2
75	1000835	JC12V-75W	11.0	44.0	30.0	C-6	1600	3000	2000	Univ	Clear	3
75	1000908	JCD120V-75W	11.5	55.0	38.0	CC-8	1100	2850	1500	BD/Hor	Clear	4
100	1000806	JC12V-100W	11.0	44.0	30.0	C-6	2300	3000	2000	Univ	Clear	3
100	1000807	JC12V-100WG	11.0	44.0	30.0	C-8	2300	3000	2000	Univ	Clear	1
100	1000381	EVA, JC12V-100H20	11.5	44.0	30.0	CBar6	2400	3000	2000	BD/Hor	Clear	3
100	1000490	FCR, JC12V-100W	11.0	44.0	30.0	CBar6	3400	3300	50	BD/Hor	Clear	3
100	1000507	FDX, JC12V-100WCG2	11.5	44.0	30.0	CBar6	3500	3300	50	Univ	Clear	5
300	1000545	FLW, JC24V-300WA-H	13.5	55.0	30.0	CBar6	10450	3500	50	Univ	Clear	5
300	1000846	JC24V-300WB	17.5	55.0	33.0	CBar6	6600	3050	1000	Univ	Clear	3

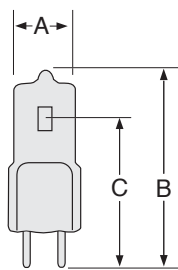

Fig.1

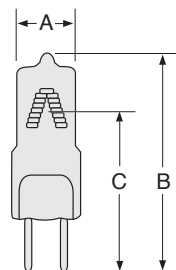

Fig.2

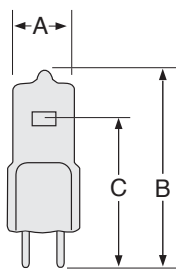

Fig.3

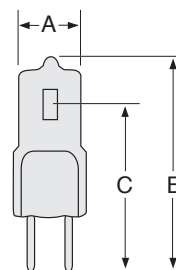

Fig.4

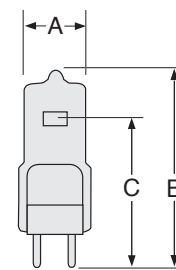

Fig.5

JCV

- Only for Use in Approved Enclosed Halogen Fixtures
- Minican Screw Base - E10/E11
- Mogul Screw Base - E39
- Universal Burn Position



Watts	Ushio Ordering Code	Ushio Lamp Description	Dimensions mm			Filament Type	Approx Lumens lm	Color Temp K	Avg Life h	Bulb Finish
			Dia (A)	MOL (B)	LCL (C)					
<b>Mini Candelabra Base – E10</b>										
150	1000479	FBT, JCV30V-150W*	11.5	60.0	27.5	CC-8	5000	3400	6	Clear
250	1000480	FBV, JCV30V-250WS*	11.5	60.0	27.5	CC-8	7850	3400	6	Clear
<b>Mini Candelabra Base - E11</b>										
75	1000988	JCV120V-75WGSN	12.0	69.0	32.0	CC-8	1125	2800	1000	Clear
75	1000989	JCV120V-75WGSNF	12.0	65.0	32.0	CC-8	1170	2850	1000	Frosted
100	1000970	JCV120V-100WGSN	14.0	69.0	32.0	CC-8	1600	2850	1000	Clear
100	1000971	JCV120V-100WGSNF	14.0	69.0	32.0	CC-8	1550	2800	2000	Frosted
100	1000361	ESN, JCV120V-100WGSN2	13.0	71.0	35.0	CC-2V	1800	2850	750	Clear
150	1000377	ETG, JCV120V-150WGSN	13.0	71.0	35.0	CC-8	2800	2900	2000	Clear
150	1000378	ETH, JCV120V-150WGSNF	13.0	71.0	35.0	CC-8	2700	2900	2000	Frosted
150	1000359	ESL, JCV120V-150WGSN2	13.0	71.0	35.0	CC-2V	2800	2900	1000	Clear
250	1000294	EHT, JCV120V-250WGSN	13.5	80.0	41.3	CC-8	5000	3000	2000	Clear
250	1000360	ESM, JCV120V-250WGSNF	13.0	80.0	41.0	CC-8	4800	3000	2000	Frosted
250	1000991	JCV130V-250WGSN	13.0	80.0	41.0	CC-8	5000	3000	2000	Clear
250	1001809	JCV130V-250WGSNF	13.0	80.0	41.0	CC-8	4850	3000	2000	Frosted
300	1000961	JCV100V-300WGS*	15.0	78.0	42.0	CC-8	4650	2850	3000	Clear
300	1001813	JCV120V-300WGS*	15.0	78.0	42.0	CC-8	4650	2950	1500	Clear
325	1000295	EHV, JCV120V-325WBS	13.0	80.0	41.0	CC-8	7800	3100	500	Clear
400	1000976	JCV120V-400WGSN	13.0	92.0	51.0	CC-8	8250	2950	2000	Clear
400	1000977	JCV120V-400WGSNF	13.0	92.0	51.0	CC-8	7850	2950	2000	Frosted
500	1000384	EVR, JCV120V-500WGS	13.0	92.0	51.0	CC-8	10450	2950	2000	Clear
500	1000466	EYX, JCV120V-500WGSF	13.0	92.0	51.0	CC-8	9500	3000	2000	Frosted
500	1000465	EYW, JCV130V-500WGS	13.0	92.0	51.0	CC-8	10000	3000	2000	Clear
500	1000464	EYV, JCV130V-500WGSF	13.0	92.0	51.0	CC-8	9500	3000	2000	Frosted
500	1000995	JCV230V-500WGS*	13.0	92.0	50.8	CC-8	9000	2950	2000	Clear
750	1000463	EYT, JCV120V-750WB1	13.0	95.0	51.0	CC-8	18500	3050	500	Clear
1000	1000967	JCV120V-1000WC3*	13.5	100.0	51.0	CC-8	26000	3200	300	Clear
<b>Mogul Screw Base – E39</b>										
2000	1000095	BWF, JCV120V-2000W	25.0	190.5	133.4	CC-8	59000	3200	500	Clear
2000	1000096	BWG, JCV120V-2000W*	25.0	190.5	133.4	CC-8	57200	3200	500	Frosted

\* Special order item

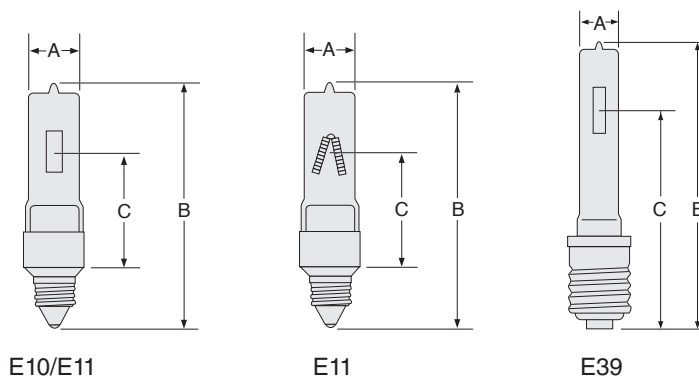



**JS**

- Only for Use in Approved Enclosed Halogen Fixtures
- 2-Pin Base - GY16
- Bipost Base - G22



Watts	Ushio Ordering Code	Ushio Lamp Description	Dimensions mm			Filament Type	Approx Lumens lm	Color Temp K	Avg Life h	Burn Position	Fig No
			Dia (A)	MOL (B)	LCL (C)						
<b>2-Pin Base – GY16</b>											
2000	1000631	FTM, JS220V-2000WCGY*	42.0	145.0	70.0	C-13	54000	3200	400	Univ	1
<b>Medium Bipost Base – G22</b>											
500	1000281	EGN, JS120V-500WC	23.0	117.0	63.5	C-13D	13000	3200	100	BD/Hor	2
750	1000282	EGR, JS120V-750WC (CP39)	23.0	127.0	63.5	C-13D	21000	3200	200	BD/Hor	2
1000	1000283	EGT, JS120V-1000WC (CP40)	23.0	127.0	63.5	C-13D	28500	3200	200	BD/Hor	2
1000	1003248	VL1K-115V, JS115V-1000WC/V	22.0	140.0	72.5	8-C-13-D	28500	3200	300	Univ	2
1000	1003273	VL1K-240V, JS240V-1000WC/V*	22.0	140.0	72.5	8-C-3-D	28500	3200	300	Univ	2

\* Special Order Item

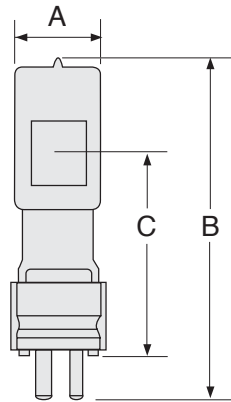

Fig.1

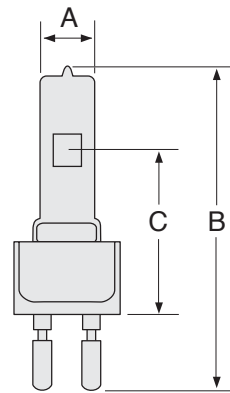

Fig.2

**JCS & JCV**

- Only for Use in Approved Enclosed Halogen Fixtures
- Medium Prefocus Base - P28s
- Mogul Prefocus Base - P40s
- 120 Volts

Watts	Ushio Ordering Code	Ushio Lamp Description	Dimensions mm			Filament Type	Approx Lumens lm	Color Temp K	Avg Life h	Burn Position	Fig No
			Dia (A)	MOL (B)	LCL (C)						
<b>Medium Prefocus Base – P28s (C-13D Filament)</b>											
500	1000083	BTL, JCS120V-500WBP28	19.5	127.0	55.5	C-13D	11000	3050	500	BD/Hor	1
500	1000084	BTM, JCS120V-500WCP28	19.5	127.0	55.5	C-13D	13000	3200	100	BD/Hor	1
500	1000208	FMC/DNS, JCS120V-500WB2P28	19.5	156.0	88.9	C-13D	11000	3050	500	Univ	2
750	1000085	BTN, JCS120V-750WBP28	23.0	127.0	55.5	C-13D	17000	3050	500	BD/Hor	1
750	1000086	BTP, JCS120V-750WCP28	23.0	127.0	55.5	C-13D	20000	3200	200	BD/Hor	1
750	1000209	FMD/DNT, JCS120V-750WB2P28	23.0	156.0	88.9	C-13D	17000	3050	500	Univ	2
1000	1000087	BTR, JCS120V-1000WCP28	23.0	127.0	55.5	C-13D	28500	3200	250	BD/Hor	1
1000	1000210	FME/DNV, JCS120V-1000WC2P28*	23.0	156.0	88.9	C-13D	27500	3200	200	Univ	2
<b>Medium Prefocus Base – P28s (CC-8 Filament)</b>											
500	1000273	EGC/EGD, JCV120V-500WC*	14.0	152.0	88.9	CC-8	12700	3150	500	Univ	3
500	1000274	EGE, JCV120V-500WB	14.0	152.0	88.9	CC-8	10450	3000	2000	Univ	3
750	1000275	EGF, JCV120V-750WC	16.0	152.0	88.9	CC-8	20400	3200	500	Univ	3
750	1000276	EGG, JCV120V-750WB	16.0	152.0	88.9	CC-8	15750	3000	2000	Univ	3
1000	1000278	EGJ, JCV120V-1000WC	19.5	152.0	88.9	CC-8	27500	3200	500	Univ	3
1000	1000279	EGK, JCV120V-1000WCF	19.5	152.0	88.9	CC-8	26500	3200	500	Univ	3
1000	1000280	EGM, JCV120V-1000WB**	19.0	152.0	88.9	CC-8	21500	3000	2000	Univ	3
<b>Mogul Prefocus Base – P40s</b>											
1000	1000091	BVT, JCS120V-1000WBP40	23.0	177.8	100.0	C-13D	23000	3050	500	Univ	4
1000	1000092	BVV, JCS120V-1000WCP40	23.0	177.8	100.0	C-13D	27500	3200	200	Univ	4
1000	1000214	DPW, JCS120V-1000W	64.0	241.3	87.3	C-13	2800	3200	50	BD	7
1500	1000145	CWZ, JCS120V-1500W	35.0	190.0	100.0	C-13D	38500	3200	325	Univ	5
1500	1000220	DTA, JCS120V-1500WCP40	25.0	203.0	87.3	C-13D	39000	3200	100	BD	6
2000	1000093	BVW, JCS120V-2000WCP40	35.0	203.2	100.0	C-13	57500	3200	300	Univ	6

\* Frosted Envelope  
 \* Special Order Item

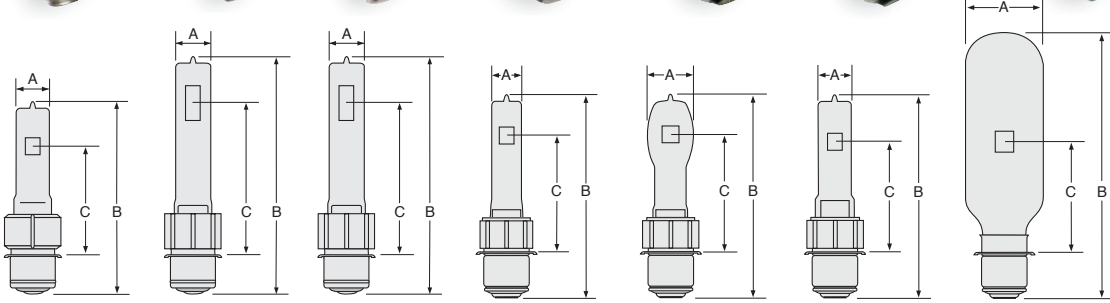

Fig. 1      Fig. 2      Fig. 3      Fig. 4      Fig. 5      Fig. 6      Fig. 7

JCD, JCS & JCV

- Only for Use in Approved Enclosed Halogen Fixtures
- 2 Button Base - G9.5
- Medium 2-Pin Base - G9.5

Watts	Ushio Ordering Code	Ushio Lamp Description	Dimensions mm			Filament Type	Approx Lumens lm	Color Temp K	Avg Life h	Burn Position	Fig No
			Dia (A)	MOL (B)	LCL (C)						
<b>2 Button Base – G9.5</b>											
600	1000248	DYP, JCD120V-600WWM	22.0	60.0	21.9	CC-6	17000	3200	75	BD/Hor	1
1000	1000891	JCD120V-1000WC*	32.0	95.0	62.0	CC-6	25000	3200	200	BD/Hor	1
<b>Medium 2-Pin Prefocus Base – G9.5</b>											
400	1003023	HX-401, JCV115V-400WBM	19.0	104.0	60.3	CC-8	8500	3050	1500	Univ	2
400	1003022	HX-400, JCV115V-400WCM	19.0	104.0	60.3	CC-8	10000	3200	300	Univ	2
500	1000286	EHC/EHB, JCV120V-500WCM	13.5	101.0	60.3	CC-8	12700	3200	300	Univ	3
500	1000287	EHD, JCV120V-500WBH	13.5	101.0	60.3	CC-8	10000	3000	2000	Univ	3
500	1001814	JCV220V-500WBM	15.0	102.0	60.3	CC-8	10500	3000	400	Univ	3
500	1000997	JCV240V-500WBM*	15.0	102.0	60.3	CC-8	10500	3000	400	Univ	3
575	1000543	FLK, HX-600, JCV115V-575WCM	18.0	104.0	60.5	CC-8	16500	3200	300	Univ	2
575	1003584	SPH115V-575W, JCD115V-575WCM	19.0	104.0	60.3	CC-6	16500	3250	300	Univ	5
575	1003585	SPH115V-575WLL, JCD115V-575WBM	19.0	104.0	60.3	CC-6	14000	3050	800	Univ	5
575	1002196	HX-601, JCV115V-575WBM	19.0	104.0	60.3	CC-8	12800	3050	1500	Univ	2
600	1000665	GLC/HP-600, JCS115V-600WCM	20.0	101.6	60.0	C-13D	15600	3200	300	Univ	4
700	1000998	JCV240V-700WCH	19.5	102.0	60.3	CC-8	18000	3200	350	Univ	3
750	1000097	BWM, JCS120V-750WC1	22.0	114.3	60.3	C-13D	21000	3200	250	BD/Hor	4
750	1000288	EHF, JCV120V-750WCH	15.0	104.0	60.3	CC-8	20400	3200	300	Univ	3
750	1000289	EHG, JCV120V-750WBH	19.0	104.0	60.3	CC-8	15400	3000	2000	Univ	3
1000	1000098	BWN, JCS120V-1000WC1	22.0	114.3	60.3	C-13D	28500	3200	200	Univ	4
1000	1000494	FCV, JCV120V-1000WCF	19.0	104.0	60.3	CC-8	26500	3200	300	Univ	3
1000	1000509	FEL, JCV120V-1000WCH	19.0	104.0	60.3	CC-8	27500	3200	375	Univ	3
1000	1000510	FEP, JCV240V-1000WCH	19.0	101.0	60.3	CC-8	25500	3200	300	Univ	3
1200	1000972	JCV120V-1200WCH	22.0	104.0	60.3	CC-8	33000	3250	200	Univ	3

\* Special Order Item

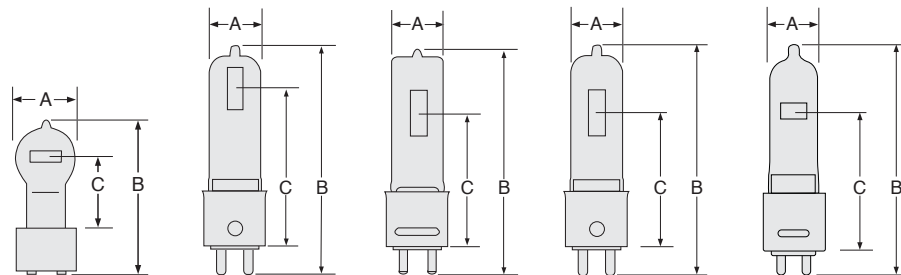

Fig.1

Fig.2

Fig.3

Fig.4

Fig.5

JC, JCD, JCS & JCV

- Only for Use in Approved Enclosed Halogen Fixtures
- 2-Pin Prefocus Base - GY9.5

Watts	Ushio Ordering Code	Ushio Lamp Description	Dimensions mm			Filament Type	Approx Lumens lm	Color Temp K	Avg Life h	Burn Position	Bulb Finish	Fig No
			Dia (A)	MOL (B)	LCL (C)							
<b>2-Pin Prefocus Base – GY9.5</b>												
80	1000171	DDJ/DZZ, JC10V-80W*	11.5	51.0	27.0	CBar6	1700	3150	1000	BD/Hor	Clear	1
100	1000459	EYL, JC12V-100WC4	11.5	62.0	36.5	CBar6	2900	3300	50	BD/Hor	Clear	1
100	1000504	FDT, JC12V-100W	11.5	57.0	27.0	CBar6	2900	3300	50	BD/Hor	Clear	1
132	1000176	DDP, JC22V-132W*	13.5	57.0	33.4	CBar6	3900	3250	125	BD/Hor	Clear	1
150	1000309	EKL, JCD21V-150W*	11.5	51.0	27.0	CC-6	4650	3350	40	BD/Hor	Clear	1
150	1000503	FDS/DZE, JC24V-150W	14.0	57.2	33.4	CBar6	5000	3400	50	BD/Hor	Clear	1
250	1000245	DYG, JCD30V-250WS	19.9	63.5	36.5	CC-6	8000	3400	15	BD/Hor	Clear	1
300	1000886	JCD100V-300WC*	22.0	63.0	36.5	CC-6	7500	3200	150	BD/Hor	Clear	2
300	1000540	FKW, JCS120V-300WC/UA	23.0	90.4	46.5	C-13	7800	3200	200	Univ	Clear	3
420	1000304	EKB, JCD120V-420WC	22.0	63.0	36.5	CC-6	11000	3200	75	BD/Hor	Clear	2
500	1000629	FTK, JCD120V-500WCT	22.0	65.3	36.5	CC-6	13500	3100	200	BD/Hor	Clear	1
500	1000914	JCD240V-500WC	24.0	62.0	36.5	2CC-8	12500	3200	50	BD/Hor	Clear	4
500	1000285	EHA, JCS120V-500W	19.5	76.0	36.5	C-13D	—	3200	75	BD/Hor	Clear	5
500	1000603	FRG, JCS120V-500WC1	23.0	90.4	46.5	C-13D	13000	3200	150	Univ	Clear	3
575	1003326	JCS120V-575WC	25.0	90.0	46.5	8-C-13D	15500	3200	300	BD	Clear	3
575	1003327	JCS120V-575WX	25.0	90.0	46.5	8-C-13D	12000	3200	1500	BD	Clear	3
600	1000251	DYS/DYV/BHC, JCD120V-600WC	22.0	63.0	36.5	CC-6	17000	3200	75	BD/Hor	Clear	2
600	1000252	DYS-5, JCD125V-600WC	22.0	63.0	36.5	CC-6	13750	3200	75	BD/Hor	Clear	2
600	1000547	FMR, JCV120V-600WGY	17.0	88.9	50.8	CC-8	12500	3000	2000	BD/Hor	Clear	6
625	1000089	BVE, JCS120V-625W	19.5	89.0	44.5	C-13D	—	3350	75	BD/Hor	Clear	5
650	1000305	EKD, JCD120V-650WS	19.9	66.0	36.5	CC-6	20000	3400	25	BD/Hor	Clear	2
650	1000604	FRK, JCS120V-650WC/UA	22.5	90.4	46.5	C-13D	17500	3200	200	Univ	Clear	3
650	1000249	DYR/220V, JCD220V-650WC1	24.0	63.0	36.5	2CC-8	16500	3200	50	BD/Hor	Clear	4
650	1000250	DYR/240V, JCD240V-650WC2	24.0	63.0	36.5	2CC-8	16500	3200	50	BD/Hor	Clear	4
800	1000909	JCD120V-800WC	24.0	62.0	36.5	CC-6	19500	3200	75	BD/Hor	Clear	2
900	1000088	BVA, JCS120V-900W	23.0	95.0	44.5	C-13D	—	3300	75	BD/Hor	Clear	3

\* Special Order Item

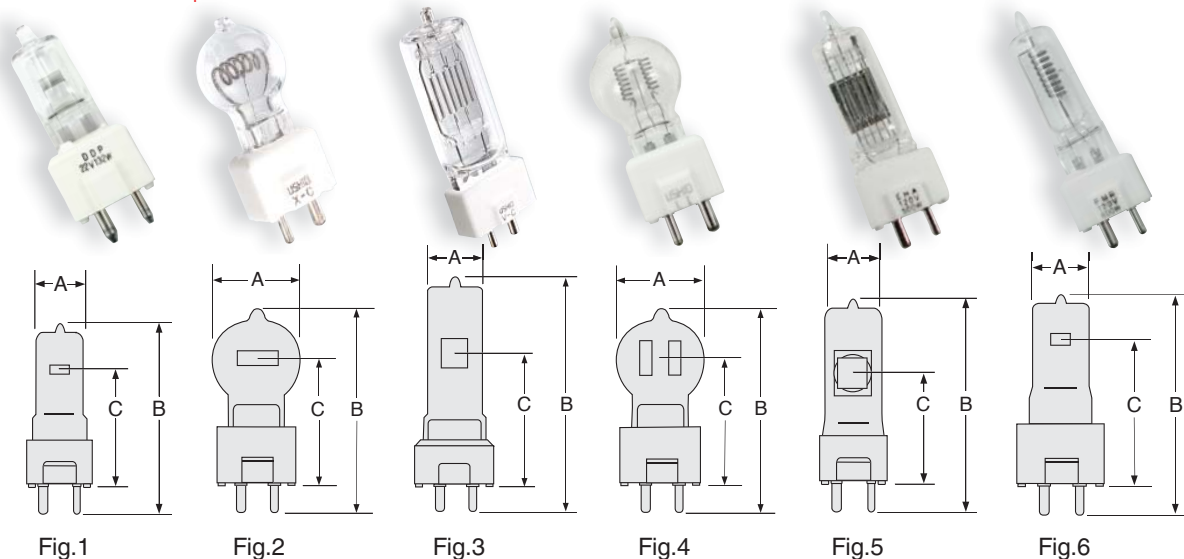

JCD, JCP & JCV

- Only for Use in Approved Enclosed Halogen Fixtures
- Medium 2-Pin Prefocus Base - GY9.5/15x19  
GY9.5/16X21, GY9.5/16X24 & GZ9.5

Watts	Ushio Ordering Code	Ushio Lamp Description	Dimensions mm			Filament Type	Approx Lumens lm	Color Temp K	Avg Life h	Burn Position	Fig No
			Dia (A)	MOL (B)	LCL (C)						
<b>Medium 2-Pin Prefocus Base – GY9.5/15x19</b>											
300	1000896	JCD120V-300WC	22.0	63.5	36.5	CC-6	7500	3200	100	BD/Hor	1
<b>Medium 2-Pin Prefocus Base – GY9.5/16x21</b>											
300	1000912	JCD230V-300WC	24.0	63.5	36.5	2CC-8	7050	3150	75	BD/Hor	2
500	1000903	JCD120V-500WC	22.0	62.0	36.5	CC-6	13000	3200	100	BD/Hor	1
650	1000906	JCD120V-650WC*	22.0	63.0	36.5	CC-6	17750	3200	75	BD/Hor	1
<b>Medium 2-Pin Prefocus Base – GY9.5/16X24</b>											
650	1002110	JCP100V-650WCC	19.5	76.0	36.5	C-13D	18750	3300	75	BD/Hor	3
<b>Medium 2-Pin Prefocus Base – GZ9.5</b>											
300	1000578	FNA, JCV120V-300WGY	16.0	88.9	50.8	CC-8	5800	3000	2000	BD/Hor	4

\* Special Order Item

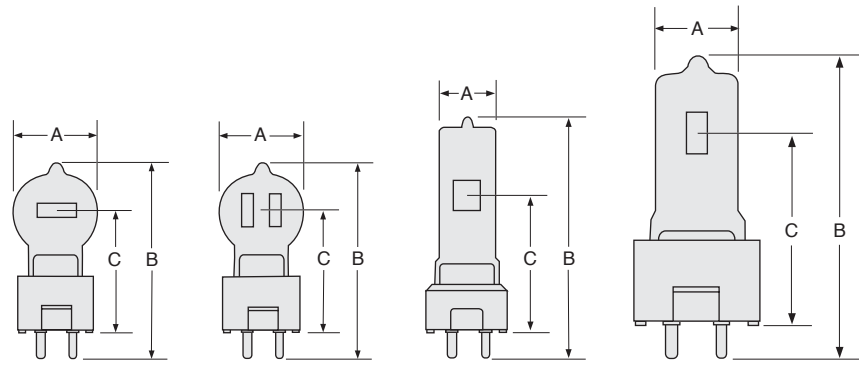

Fig.1                      Fig.2                      Fig.3                      Fig.4

**JCS**

- Only for Use in Approved Enclosed Halogen Fixtures
- 4-Pin Base - G17t-7
- Standard Voltage (120 volts)
- Monoplane Filament

Watts	Ushio Ordering Code	Ushio Lamp Description	Dimensions mm			Filament Type	Approx Lumens lm	Color Temp K	Avg Life h	Burn Position	Fig No
			Dia (A)	MOL (B)	LCL (C)						
<b>4-Pin Base – G17t-7</b>											
1200	1000072	BRN, JCS120V-1200W	23.0	95.0	38.7	C-13D ○	—	3350	20	BD/Hor	1
1200	1000082	BTG, JCS120V-1200W	23.0	95.0	39.7	C-13D ○	38200	3350	20	BD	1

○ Proximity Reflector

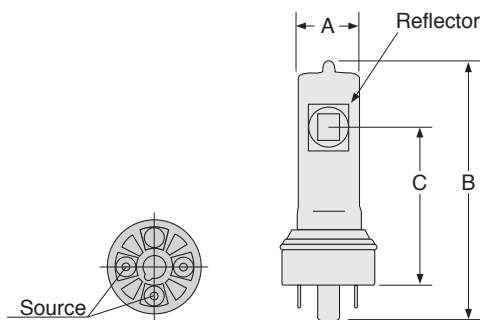

Fig.1

JS

- Only for Use in Approved Enclosed Halogen Fixtures
- Mogul Bipost Base - G38



Watts	Ushio Ordering Code	Ushio Lamp Description	Dimensions mm			Filament Type	Approx Lumens lm	Color Temp K	Avg Life h	Burn Position	Fig No
			Dia (A)	MOL (B)	LCL (C)						
<b>Mogul Bipost Base – G38</b>											
1000	1000154	CYV, JS120V-1000WC2	23.0	200.0	127.0	C-13	28500	3200	200	BD/Hor	1
1500	1000150	CXZ, JS120V-1500W*	40.0	210.0	127.0	C-13	44500	3200	400	BD	2
2000	1000094	BWA, JS120V-2000W/G38	25.0	203.2	127.0	CC-8	54000	3200	500	Univ	3
2000	1000155	CYX, JS120V-2000WC	40.0	210.0	127.0	C-13	59000	3200	300	BD/45°	2
5000	1000215	DPY, JS120V-5000WC	60.0	268.0	165.0	C-13	145000	3200	500	BD/45°	4
10000	1000222	DTY, JS120V-10000WC	80.0	391.0	254.0	C-13	285000	3200	500	BD/45°	5
10000	1000223	DTY/220V, JS220V-10000WG38	80.0	400.0	254.0	C-13	290000	3200	400	BD/45°	5
20000	1002288	BCM (208V) JS208V-20000W/C	100.0	550.0	354.0	C-13	580000	3200	400	BD/45°	6
20000	1002165	BCM, JS225V-20000W	100.0	550.0	354.0	C-13	580000	3200	400	BD/45°	6

\* Special Order Item

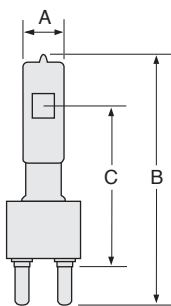

Fig.1

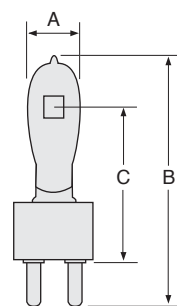

Fig.2

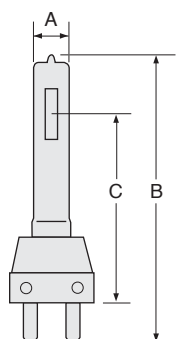

Fig.3

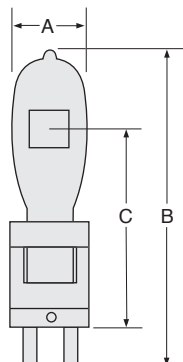

Fig.4

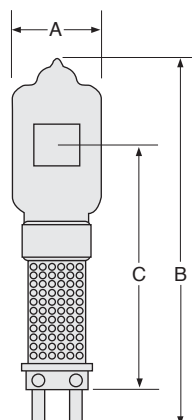

Fig.5

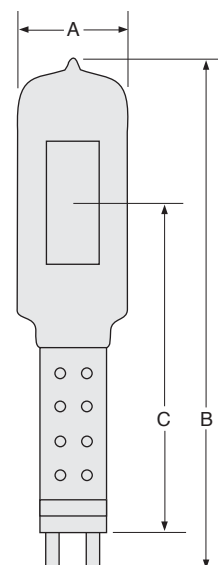

Fig.6

**JT**

- Only for Use in Approved Enclosed Halogen Fixtures
- Medium Screw Base - E26  
Mogul Screw Base - E39/E40
- Double Envelope
- 120 Volt (except as noted)
- Universal Burn Position

Watts	Ushio Ordering Code	Ushio Lamp Description	Dimensions mm			Filament Type	Approx Lumens lm	Color Temp K	Avg Life h	Bulb Finish
			Dia (A)	MOL (B)	LCL (C)					
<b>Medium Screw Base – E26 Compact Version</b>										
100	1001137	JT120V-100WG	31.0	85.0	51.0	CC-8	1600	2800	1500	Clear
150	1001883	JT120V-150WG*	31.0	85.0	54.0	CC-8	2800	2800	2000	Clear
250	1001141	JT120V-250WG	31.0	105.0	58.0	CC-8	5000	2950	2000	Clear
250	1001142	JT120V-250WGF*	31.0	105.0	58.0	CC-8	4850	2950	2000	Frosted
<b>Mogul Screw Base – E39/E40</b>										
500	1001143	JT120V-500WB	40.0	193.0	123.0	C-8	11000	3200	2000	Clear
500	1003516	JT220V-500WC1/E40*	42.0	195.0	123.0	C-8	12500	3200	200	—
1000	1001134	JT120V-1000WB	42.0	260.0	157.0	C-8	22000	3050	2000	Clear
1000	1003361	JT120V-1000WC/E40	42.0	195.0	123.0	C-8	25000	3200	150	Clear
1000	1003517	JT220V-1000WC1/E40*	42.0	195.0	123.0	C-8	25000	3200	200	—
1000	1001889	JT240V-1000WB*	42.0	260.0	175.0	C-8	21500	3400	2000	Clear

\* Special Order Item

JT type Halogen lamps are double enveloped lamps in which a Halogen lamp serves as an inner tube.

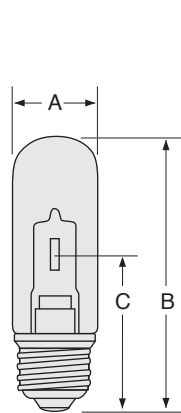

E26 - Clear or Frosted Compact Version

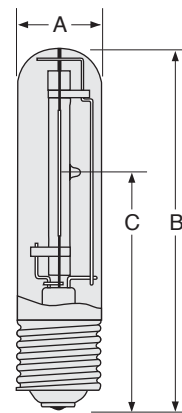

E39 and E40